

**New Zealand Country Report: Ecologically Related
Species in the New Zealand Southern Bluefin Tuna
Longline Fishery**

Prepared for ERSWG9

February 2012

1. INTRODUCTION.....	1
2. REVIEW OF SOUTHERN BLUEFIN TUNA FISHERIES IN THE NEW ZEALAND EXCLUSIVE ECONOMIC ZONE.....	2
<i>Fleet Size and Distribution</i>	2
Annual Fleet Size and Distribution.....	2
Historical Fleet Size and Distribution.....	2
<i>Distribution of Catch and Effort</i>	2
3. FISHERIES MONITORING.....	3
<i>Observer Coverage</i>	3
Recent Observer Coverage.....	3
Observer Collection of Information.....	3
<i>Other Data Collection</i>	4
Southern Bluefin Tuna.....	4
Fish Bycatch.....	4
4. SEABIRDS.....	5
<i>Total seabird bycatch estimates for 2008-09</i>	5
5. NON-TARGET FISH.....	5
6. MARINE MAMMAL AND MARINE REPTILE BYCATCH.....	7
<i>Marine mammals</i>	7
Total Fur Seal Bycatch Estimates for 2006-07 and 2007-08.....	7
<i>Marine reptiles</i>	7
7. MITIGATION MEASURES TO MINIMISE SEABIRD AND OTHER SPECIES BYCATCH.....	7
<i>Current measures</i>	7
Mandatory measures for each fleet.....	7
Voluntary measures for each fleet.....	8
Measures under development.....	8
8. PUBLIC RELATIONS AND EDUCATION ACTIVITIES.....	8
9. INFORMATION ON OTHER ECOLOGICALLY RELATED SPECIES (NON-BYCATCH).....	9
10. OTHERS.....	9
11. IMPLEMENTATION OF THE IPOA-SEABIRDS AND IPOA-SHARKS.....	9
<i>National Plan of Action to Reduce the Incidental Catch of Seabirds in New Zealand Fisheries</i>	9
<i>National Plan of Action Sharks</i>	10
ACKNOWLEDGEMENTS.....	10
REFERENCES.....	10
APPENDIX I – ABSTRACTS OF NEW ZEALAND MEETING PAPERS FOR ERSWG9.....	19
APPENDIX II – CODE OF PRACTICE.....	22
Annex 1: Fisheries (Seabird Mitigation Measures—Surface Longlines) Circular 2011 (No. F629).....	43

1. INTRODUCTION

Since the start of New Zealand's domestic southern bluefin tuna (SBT) fishery, handline, trolling and longline have been used to target SBT in the NZ Exclusive Economic Zone (EEZ). All but a few tonnes of the domestic SBT catch is now taken by longline.

SBT is seasonally present in New Zealand from March/April to August/September. Fishing takes place in two areas, off the east coast of the North Island north of 42° S and off the west coast of the South Island south of 42° S. The distribution of SBT catches are shown in Figure 1 (domestic fishery) and Figure 2 (charter fleet).

Longlining off the west coast of the South Island is almost entirely targeted at SBT. The fleet operating off the southwest coast is primarily composed of the larger –60^o freezer vessels of the charter fleet. The generally heavier weather conditions off the west coast of the South Island compared to the east coast of the North Island means that few of the smaller domestic owned and operated vessels operate in this area. Smaller domestically owned and operated “ice boats” operate in the longline fishery off the east coast of the North Island. These vessels are typically at sea for only a few days, and land SBT both as a target and as a bycatch of bigeye target sets.

Non-target fish species such as sharks, Ray's bream, albacore and dealfish are caught in large numbers as bycatch on tuna longlines. Nine taxa of seabirds were recorded as bycatch during 2008-09, with conservation status of the species ranging from Endangered to Least Concern. New Zealand fur seals were captured during fishing for SBT during 2007-08, almost all of which were released alive. Whales and sea turtles are also caught in surface longline fisheries for SBT from time to time, although such captures are rare.

New Zealand has National Plans of Action in place for both seabirds and sharks. Both plans of action will be reviewed and updated in 2012. Mandatory seabird mitigation measures are in place, in line with agreements in the Commission for the Conservation of Southern Bluefin Tuna (CCSBT) and the Western and Central Pacific Fisheries Commission (WCPFC). Surface longline vessels also carry turtle mitigation equipment (line cutters, de-hookers, and nets).

Note that Appendix I contains a very brief summary of the meeting papers submitted by New Zealand to ERSWG 9.

2. REVIEW OF SOUTHERN BLUEFIN TUNA FISHERIES IN THE NEW ZEALAND EXCLUSIVE ECONOMIC ZONE

Fleet Size and Distribution

Annual Fleet Size and Distribution

Longline fishing targeting SBT primarily occurs off the west coast of the South Island south of 42° S and along the east coast of the North Island north of 42° S. SBT also comprises a bycatch in the bigeye target fishery in the Bay of Plenty. Figure 3 (domestic fishery) and Figure 4 (charter fleet) show the distribution of SBT effort.

The number of vessels fishing by surface longline peaked in 2002 and then declined to a low of 35 vessels in 2008, and has since increased again to 42 in 2009-10, most of which are small vessels (< 50 GRT). In 2005 and 2006 only two charter vessels fished for SBT in New Zealand fisheries waters, but this increased again to four in subsequent years.

Historical Fleet Size and Distribution

The New Zealand SBT fishery began off the west coast of the South Island as a winter small boat handline and troll fishery in the early 1980s. Most fishing by these vessels was in July and August. Since 1990, however, these methods have comprised only a minor component of the fishery as longline vessels had generally caught the SBT quota by the time the handline fishery started.

During the 1980s to mid-1990s most longlining was conducted by foreign licensed longliners from Japan. However, declining catch rates, shortened seasons of availability and reports of increased operating costs in the EEZ resulted in the foreign licensed fleet ceasing operations in 1995. Domestic longlining began in 1991 and steadily increased to over 150 vessels in 2002 before declining to 35 vessels by 2008, with a slight increase to 42 vessels in 2010.

Distribution of Catch and Effort

Table 1 gives the total estimated SBT catch by gear type since 1999. With the advent of domestic longline fishing (starting in 1990) longline effort has almost completely replaced fishing effort by trolling and handline. A small SBT bycatch still occurs in the mid-water trawl fishery (for example 0.3t in 2008). Table 2 summarises total SBT catches by calendar year and fishing year (1 October to 30 September).

The charter fleet primarily operates off the west coast of the South Island while smaller domestic owned and operated vessels primarily operate off the east coast of the North Island (see Figure 3 and Figure 4). The fishing season for SBT is essentially the same for both areas and generally begins in April/May and finishes in July/August.

3. FISHERIES MONITORING

Observer Coverage

Recent Observer Coverage

New Zealand has a scientific Observer Programme that covers both domestic and charter longline vessels. In most years, all trips made by the charter vessels are covered by at least one observer (2007 and 2008 being recent exceptions in which only two of the four vessels were observed). The target coverage level for the domestic fleet is 10% of the effort to reflect 10% of the catch.

Coverage is measured in two ways, proportion of catch (in numbers of fish) observed (Table 3) and proportion of hooks observed (Table 4). In terms of catches, around 89% of the catch was observed (and measured) in the charter fleet in 2009 and around 84% in 2010. For the domestic fleet, 10% of the catch was observed in 2009 and 7% in 2010.

In terms of effort, 82% of hooks were observed on the charter vessels in 2009, and 80% in 2010. For the domestic fleet 8% of the effort was observed in 2009 and 7% in 2010. In the past, the small size of domestic owned and operated vessels and short trips has made it difficult for MAF to realise the 10% target for observer coverage in this fleet, but efforts have been made to improve coverage in recent years.

Because only one observer is present on the vessel, and the observer takes breaks during the long hauling process on the Charter vessels, it is not possible to observe all hooks on these vessels. The observer accurately reports the portions of the haul that are not observed. The proportion of the catch observed is higher than hooks observed because some unobserved catches are recorded (and sometimes measured) as they are available to the observer after their break. Unobserved catches which are measured are noted.

Observer Collection of Information

Biological Information

Observers from the scientific Observer Programme are responsible for collecting biological data on SBT and bycatch data for catch characterisation.

Length, weight (both processed and whole weights) and sex are recorded regularly for SBT and all major fish bycatch species.

Full biological information is recorded for non-fish species (e.g. seabirds, turtles, marine mammals).

Fish Bycatch Estimates

Data from the Observer Programme are used to quantify the extent of fish bycatch caught on tuna longlines in New Zealand waters. These data provide information on which species appeared as bycatch, the catch per unit effort (CPUE) of the most common species, and estimates of total catch.

Other Data Collection

Southern Bluefin Tuna

From 1 October 2004, when SBT was introduced into the quota management system (QMS), the catch monitoring and catch balancing systems in place for all other New Zealand quota species were applied to SBT. All fishers are required to furnish monthly returns of catch (in addition to furnishing log books). These monthly returns are then matched to individual holdings of quota entitlement. Financial penalties will apply to fishers (on a monthly basis) who catch SBT other than under the authority of quota. Fishers have the opportunity to reconcile their catch and quota entitlements up until the end of the fishing year and if they do not do so the financial penalties increase.

Fish Bycatch

Quota Species

The main fish species associated with the SBT fishery within the New Zealand EEZ were introduced into the QMS on 1 October 2004. All fishers are required to furnish monthly returns of catch for these associated species (in addition to furnishing log books). Financial penalties apply to fishers who do not furnish returns, do not hold quota entitlement, or whose catch exceeds their entitlements.

The total allowable catch of each of the main fish bycatch species associated with New Zealand's SBT longline fishery is presented in Table 5.

Non-quota Species

Some species caught as bycatch in the SBT fishery are not managed under the QMS. Examples include albacore and striped marlin. However, fishers are required to report the catch of all species, including any non-QMS species, when furnishing their monthly returns. As a result, the commercial reporting requirements provide information on total catch and effort of fish bycatch in the SBT fishery.

For additional information on quota and non-quota species bycatch, see section 5 below.

4. SEABIRDS

This section summarises Abraham and Thompson (2011) as submitted to ERSWG 9.

A total of 57 seabirds from 9 taxa were observed caught during 2008-09 in New Zealand's SBT longline fishery. Species ranged in conservation status from rare to abundant. The birds were landed both dead and alive (this indicates that birds were caught both at the set and during the haul, and mitigation techniques need to be applied during both parts of the fishing operation to avoid seabird captures).

Total seabird bycatch estimates for 2008-09

A total of 127 (93-180 95% CI) seabirds were estimated caught in the southern bluefin tuna longline fishery in 2008-09. Reasonable observer was achieved, with 48.6% of hooks observed.

It was estimated that the total seabird catch was approximately 274 (180-477 95% CI) in 2006-07 and 103 (65-167 95% CI) in 2007-08.

The observed seabird bycatch rate per 1000 hooks was 0.080 in 2008-09.

5. NON-TARGET FISH

This section summarises fish catches taken in tuna longline sets that either targeted or caught southern bluefin tuna. Numbers of fish observed, and estimated numbers scaled from observer to the commercial fishing effort during the 2009 and 2010 calendar years are shown in Table 6. Catch per unit effort is also shown in Table 6. The scaled estimates provided for the domestic fleet can be considered less reliable than those of the charter fleet as they are based on lower observer coverage.

The species most commonly caught were blue shark (*Prionace glauca*), Ray's bream (*Brama brama*), and albacore (*Thunnus alalunga*). Other non-target fish caught in relatively large numbers were dealfish (*Trachipterus trachipterus*), bigscale pomfret (*Taractichthys longipinnis*), porbeagle shark (*Lamna nasus*), deepwater dogfish (Squaliformes of various species, mostly Owstons dogfish), swordfish (*Xiphias gladius*), lancetfish (*Alepisaurus ferox* & *A. brevirostris*), mako shark (*Isurus oxyrinchus*), moonfish (*Lampris guttatus*), swordfish (*Xiphias gladius*), and butterfly tuna (*Gasterochisma melampus*).

The next most abundant non-target fish species were oilfish (*Ruvettus pretiosus*), school shark (*Galeorhinus galeus*), rudderfish (*Centrolophus niger*), hoki (*Macruronus novaezelandiae*), escolar (*Lepidocybium flavobrunneum*), and thresher shark (*Alopias vulpinus*). In 2009 and 2010, sunfish (*Mola mola*), flathead pomfret (*Taractes asper*), and Pelagic stingray (*Pteroplatytrygon violacea*) were also amongst the 25 most abundant species. Some other non-target tunas and billfish were caught, including Pacific bluefin tuna (*Thunnus orientalis*), skipjack tuna (*Katsuwonus pelamis*), yellowfin tuna (*Thunnus albacares*), and striped marlin (*Tetrapturus audax*).

Bycatch composition from the charter fleet and the domestic fleet is different. This is likely to be due to differences in waters fished, with the charter fleet mostly operating in southern waters, and the domestic vessels fishing primarily in waters north of about 40°S. Charter

vessels fished north of East Cape late in the 2009 season but only fished off the West Coast of the South Island in 2010 and this resulted in a different catch composition in the two years.

In both 2009 and 2010, blue shark, Ray's bream, and albacore were predominant in the catches overall, with these three species making up nearly 70% of the catch. Charter vessels caught mostly blue sharks and Ray's bream, with blue sharks the most abundant species in the catch in 2009 and Ray's bream higher in 2010. Blue sharks dominated the catches of the domestic vessels, followed by albacore.

Dealfish, bigscale pomfret, and deepwater dogfish were caught in the south by charter vessels, while domestic vessels caught lancetfish, swordfish, and mako sharks in the north. Both caught porbeagle sharks, moonfish and butterfly tuna. Oilfish and escolar were caught in the north, with oilfish recorded by both fleets and escolar by domestic vessels only. Bigscale pomfret and escolar have been more important components of the catch in recent years than in earlier years, possibly because of improved identification.

Observers onboard both the charter and domestic fleets reported on fish that were caught and subsequently discarded, and fish that were lost before they could be brought aboard the vessel. Observers also recorded whether fish were landed alive or dead.

Since their introduction into the QMS, most Ray's bream and moonfish have been retained. Blue, porbeagle and mako sharks have also been discarded less frequently since their introduction into the QMS. There were some differences between the domestic and charter fleet, with the domestic fleet more likely to discard sharks.

Most blue sharks were finned; mako sharks were often retained for their flesh (as well as fins), particularly by the charter fleet; and porbeagle sharks were usually finned and sometimes retained for their flesh. However domestic vessels released or discarded much of their catch of these shark species. School shark was normally retained and thresher sharks were usually discarded although some were kept by the charter vessels.

Tunas (other than butterfly tuna) and swordfish were seldom discarded. The charter vessels kept most of the butterfly tuna they caught while domestic vessels discarded more than half of it in 2009 and kept the majority of it in 2010. Almost all of the lancetfish, deepwater dogfish, and dealfish caught were discarded. Charter vessels discarded oilfish and rudderfish and while domestic vessels retained the majority of oilfish, rudderfish, and escolar. Charter vessels kept the majority of their bigscale pomfret in 2009 and discarded the majority of it in 2010.

Tunas that were discarded were usually dead (and typically damaged). Most of the sharks that were discarded were alive when they were landed, although some dead sharks were discarded by domestic vessels. Porbeagle sharks did not survive as well on longlines as the other sharks. Most butterfly tuna discarded by the domestic vessels were dead when landed. The majority of the other fish bycatch species that were commonly discarded were landed alive.

Observers record life status on landing but they do not record if live fish are still alive at time of discard. Fish that are landed alive and subsequently discarded are not necessarily returned to the sea alive. Many fishers retrieve their hooks prior to discarding fish and this often damages the fish and reduces its ability to survive. Some species such as dealfish do not survive the de-hooking process.

6. MARINE MAMMAL AND MARINE REPTILE BYCATCH

Marine mammals

This section summarises Abraham and Thompson (2011) as submitted to ERSWG 9.

Twenty-two New Zealand fur seals (*Arctocephalus forsteri*) were observed captured during fishing for southern bluefin tuna during 2008-09. Almost all of these were released alive.

No other marine mammal captures were observed during fishing for southern bluefin tuna in 2008-09.

Total Fur Seal Bycatch Estimates for 2006-07 and 2007-08

A total of 46 (41-53 95% CI) fur seals were estimated caught in the southern bluefin tuna longline fishery in 2008-09. Reasonable observer was achieved in 2008-09, with 48.6% of hooks observed.

It was estimated that the total fur seal bycatch was approximately 48 (42-57 95% CI) in 2006-07 and 35 (31-41 95% CI) in 2007-08.

The observed fur seal bycatch rate per 1000 hooks was 0.031 in 2008-09.

Marine reptiles

Marine reptiles are rarely encountered in New Zealand waters. None were observed caught in 2008-09 during fishing for southern bluefin tuna

7. MITIGATION MEASURES TO MINIMISE SEABIRD AND OTHER SPECIES BYCATCH

Current measures

Mandatory measures for each fleet

Tori lines are mandatory as a mitigation measure in place to avoid capture of non-fish species for tuna longliners in New Zealand waters. The use of tori lines was regulated in 1993. Specifications of the required minimum tori line refer to its length and attachment point, as well as the number, size and distance between streamers. These specifications have been recently updated to bring them in line with agreements reached in the Western and Central Pacific Fisheries Commission. In addition, fishers must set their lines at night, or, if fishing during the daytime, use approved line weighting.

Similar provisions are also outlined in high seas permit conditions for any New Zealand vessels fishing on the high seas.

Voluntary measures for each fleet

Voluntary mitigation measures stipulated in any formal way are done so through Codes of Practice. A Code of Practice is in place for domestic tuna vessels (see Appendix II). For charter vessels operated through the New Zealand Japan Tuna Co. Ltd., a Code of Practice is in place that stipulates a range of additional measures that can be used to reduce seabird captures. The specific measures used vary both from vessel to vessel, and in response to specific circumstances (e.g. in response to seabird captures), but include:

- One or two additional tori lines, which can help maximise the coverage of tori lines over the baited hooks;
- Various line weighting regimes;
- Bait casters (these are not a mitigation device per se but can help distribute hooks within the zone covered by the tori line);
- Offal retention;
- Particular attention to the need for and importance of mitigation measures over the period of the full moon, when captures are most likely;
- Haul mitigation including water cannons or hoses and bird curtains; and
- A catch limit for 'at risk' species of birds.

In addition, vessels are encouraged to try out mitigation methods they believe may be effective. It is also noted that vessels may need to deploy additional mitigation devices at times of high risk such as immediately before and after the full moon.

*Measures under development***Measures to improve the safety of line weighting**

The Ministry of Agriculture and Forestry, in conjunction with Birdlife International, plans to trial the use of safe lead weights in the surface longline fishery to assess their effect on fish catches as well as their safety for fishers. Their effectiveness as a mitigation measure has been demonstrated elsewhere, although this will also form a component of the trials. Fisher safety represents a barrier to greater uptake of line weighting in New Zealand at present. It is anticipated the results of the trials could be presented to the next meeting of the ERSWG.

8. PUBLIC RELATIONS AND EDUCATION ACTIVITIES

The New Zealand government continues to engage with fishers to increase their awareness of bycatch issues in New Zealand fisheries. These public relations activities, education, and information exchange with respect to SBT fisheries are described below.

The primary means of engagement with surface longline fishers is through bi-annual workshops, where mitigation of captures of seabirds and other ERS are routinely discussed. The Ministry of Agriculture and Forestry continues to distribute equipment to release tangled or hooked animals (for example marine turtles) to new vessels entering the fleet, along with associated education materials. The Ministry, in conjunction with an industry organisation the Seafood Industry Council, has also produced a Code of Best Practice for fishers, which is updated annually. The latest version is attached at Appendix II. The code of practice is distributed to quota holders and vessel masters, as well as licensed receivers of fish.

In addition to Government activities, the organisation Southern Seabird Solutions (www.southernseabirds.org), formed in 2002, continued its work in education and awareness of seabird conservation. The organisation's priority projects at present include:

- An **International Mitigation Mentor Programme** to provide feedback and advice to fishers and other inventors on their mitigation ideas;
- Drawing on the knowledge of leaders in the recreational sector to find out more about the interaction between seabirds and **recreational fishing**;
- A **Seabird Smart Training Programme** to establish and run a training programme that educates and inspires fishers to carry out seabird smart fishing practices while on the water; and
- Supporting **South Africa's Responsible Fisheries Alliance**, including a workshop to share the experiences of the Southern Seabird Solutions Trust with this organisation.

9. INFORMATION ON OTHER ECOLOGICALLY RELATED SPECIES (NON-BY-CATCH)

Since 1994, MFish observers aboard tuna longline vessels in New Zealand waters have recorded data on stomach contents of fish taken in longline operations. A preliminary examination of these data has been made for SBT and eight other ecologically related species and is summarised in document CCSBT-ERS/0602/8. Collection of stomach content information has continued but the more recent data has not yet been analysed. A project is proposed to undertake this analysis in 2012.

10. OTHERS

New Zealand has no information to report on ERS-related fishing activities of non-party fleets.

11. IMPLEMENTATION OF THE IPOA-SEABIRDS AND IPOA-SHARKS

National Plan of Action to Reduce the Incidental Catch of Seabirds in New Zealand Fisheries

The NPOA-Seabirds is the principal framework for mitigating the impact of fisheries mortalities on seabirds. Its purpose is to set out a long-term strategy to reduce the incidental catch of seabirds in New Zealand fisheries. The Minister of Conservation and the Minister of Fisheries jointly approved the NPOA-Seabirds in April 2004.

The goals of the NPOA-Seabirds are:

- To ensure that the long-term viability of protected seabird species is not threatened by their incidental catch in New Zealand fisheries waters or by New Zealand flagged vessels in the high seas; and
- To further reduce incidental catch of protected species as far as possible, taking into account advances in technology, knowledge and financial implications.

The NPOA-Seabirds is currently being revised to ensure that it is effective, taking into account the recent IPOA Guidelines issued by the FAO. The revised approach is likely to use a risk assessment methodology to determine priority fisheries where additional management action may be necessary to reduce mortalities to biologically acceptable levels. The seabird risk assessment methodology and results are described in Richard et al. (2011), which has been submitted to ERSWG 9.

In addition, best practice measures will likely be implemented across all fisheries that pose a risk to seabirds, with the aim of minimising seabird interactions in a safe and practical manner. Mandatory measures are already in place in all longline fisheries and for larger trawl vessels. In addition, a range of voluntary measures are in place or being developed for other high risk fisheries.

National Plan of Action Sharks

New Zealand finalised its NPOA-Sharks for New Zealand fisheries waters in October 2008. The NPOA-sharks recognises that New Zealand has already taken a number of management actions in recent years to ensure the sustainable management of New Zealand shark fisheries. These actions include introducing a range of shark species into the QMS and providing complete protection for some vulnerable species. The NPOA-Sharks also identifies additional actions in order to achieve the objectives identified in the IPOA-Sharks.

A review of the NPOA-Sharks is scheduled for 2012, and will include an assessment of progress against actions identified in the existing NPOA and the IPOA-Sharks, as well as development of additional actions as appropriate. As part of the review, the catch limits and other management controls for various HMS sharks, including oceanic whitetip sharks, hammerheads, porbeagle, and mako may be reviewed.

ACKNOWLEDGEMENTS

MAF acknowledges Terese Kendrick, Malcolm Francis and Lynda Griggs for assistance with various parts of this report.

REFERENCES

Abraham, E. R., and Thompson, F. N. (2011). Summary of the capture of seabirds, marine mammals, and turtles in New Zealand commercial fisheries, 1998–99 to 2008–09. New Zealand Aquatic Environment and Biodiversity Report No. 80.

Richard, Y., Abraham, E. R., & Filippi, D. (2011). Assessment of the risk to seabird populations from New Zealand commercial fisheries. Final Research Report for research projects IPA2009-19 and IPA2009-20. Unpublished report held by MAF, Wellington.

Table 1: The annual southern bluefin tuna catch (tonnes whole weight) for calendar years 1999 to 2010, by fishing method. Annual total catch estimates are scaled to Licensed Fish Receiver returns for 1999 to 2001, and to Monthly Harvest Returns since 2002, 0.0 = less than 100 kg.

Calendar year	Fishing method				Total
	Longline	Troll	Handline	Other	
1999	455.8	3.0	1.8	0.0	460.6
2000	379.5	0.7	0.2	0.0	380.3
2001	358.3	0.1	0.1	0.0	358.5
2002	449.7	0.6	0.0	0.0	450.3
2003	389.3	0.1	0.2	0.0	389.6
2004	391.2	1.4	0.7	0.0	393.3
2005	261.4	3.0	0.0	0.0	264.4
2006	235.9	0.1	2.2	0.0	238.2
2007	377.2	1.3	0.0	4.0	382.6
2008	318.6	0.0	0.0	0.4	319.0
2009	411.6	7.2	0.0	0.0	418.7
2010	500.6	0.1	0.0	0.0	500.7

Table 2: Recent catches of southern bluefin tuna in New Zealand fisheries waters (tonnes whole weight) by Calendar year and New Zealand fishing year (1 October to 30 September).

Year	Calendar year catches	Fishing year catches
1980	130.0	130.0
1981	173.0	173.0
1982	305.0	305.0
1983	132.0	132.0
1984	93.0	93.0
1985	94.0	94.0
1986	82.0	82.0
1987	59.0	59.0
1988	94.0	94.0
1989	437.2	437.1
1990	529.2	529.3
1991	164.5	164.5
1992	279.2	279.2
1993	216.6	216.3
1994	277.0	277.2
1995	436.4	434.7
1996	139.3	140.4
1997	333.7	333.4
1998	337.1	333.0
1999	460.6	457.5
2000	380.3	381.7
2001	358.5	359.2
2002	450.3	453.6
2003	389.6	391.7
2004	393.3	394.0
2005	264.4	264.0
2006	238.2	238.2
2007	382.6	383.1
2008	319.0	318.8
2009	418.5	417.3
2010	500.7	499.9

Table 3: Observer coverage in terms of catch (proportion of fish numbers observed) for the Charter (NZC) and domestic (NZD) fleets for 2009 and 2010.

Calendar year	NZC	NZD
2009	0.89	0.10
2010	0.84	0.07

Table 4: Observer coverage in terms of effort (proportion of hooks observed) for the Charter (NZC) and domestic (NZD) fleets for 2009 and 2010.

Calendar year	NZC	NZD
2009	0.82	0.08
2010	0.80	0.07

Table 5: Total allowable catches of the main fish bycatch species associated with the SBT surface longline fishery within the NZ EEZ as at 1 October 2011.

Fish species	TAC (tonnes)
Bigeye tuna	740
Yellowfin tuna	358
Pacific bluefin tuna	145
Swordfish	919
Moonfish	527
Blue shark	2080
Mako shark	512
Porbeagle shark	249
Ray's bream	1045

Table 6: Numbers of fish caught reported on commercial catch effort returns (Reported), observed, estimated from observer reports and total fishing effort (Scaled), and catch per unit effort (CPUE) for fish species caught on longline sets where southern bluefin tuna was either targeted or caught during the 2009 and 2010 calendar years.

2009	Charter			New Zealand Domestic		
	Observed	Scaled	CPUE	Observed	Scaled	CPUE
Blue shark	5 727	7 057	8.784	3 496	41 615	49.433
Rays bream	4 656	5 737	7.141	97	1 155	1.372
Albacore tuna	526	648	0.807	1 131	13 463	15.992
Dealfish	608	749	0.933	1	12	0.014
Big scale pomfret	446	549	0.684	0	0	0.000
Porbeagle shark	256	315	0.393	176	2 095	2.489
Deepwater dogfish	439	540	0.673	0	0	0.000
Swordfish	40	49	0.061	185	2 202	2.616
Lancetfish	31	38	0.048	101	1 202	1.428
Mako shark	77	94	0.118	156	1 857	2.206
Moonfish	103	126	0.158	77	917	1.089
Butterfly tuna	96	118	0.147	91	1 083	1.287
Oilfish	168	207	0.258	19	226	0.269
School shark	132	162	0.202	4	48	0.057
Sunfish	8	9	0.012	61	726	0.863
Rudderfish	62	76	0.095	14	167	0.198
Flathead pomfret	51	62	0.078	0	0	0.000
Escolar	0	0	0.000	17	202	0.240
Pelagic stingray	0	0	0.000	26	309	0.368
Thresher shark	13	16	0.020	3	36	0.042
Hoki	10	12	0.015	0	0	0.000
Pacific bluefin tuna	0	0	0.000	4	48	0.057
Skipjack tuna	0	0	0.000	1	12	0.014
Striped marlin	0	0	0.000	0	0	0.000
Yellowfin tuna	0	0	0.000	1	12	0.014

Table 6: continued.

2010	Charter			New Zealand Domestic		
	Observed	Scaled	CPUE	Observed	Scaled	CPUE
Blue shark	2 024	2 501	5.226	5 062	57 834	46.406
Rays bream	3 295	4 072	8.508	362	4 136	3.319
Albacore tuna	90	111	0.232	1 219	13 927	11.175
Dealfish	882	1 090	2.277	7	80	0.064
Big scale pomfret	349	431	0.901	3	34	0.028
Porbeagle shark	72	89	0.186	279	3 188	2.558
Deepwater dogfish	305	377	0.788	0	0	0.000
Swordfish	3	4	0.008	269	3 073	2.466
Lancetfish	3	4	0.008	337	3 850	3.089
Mako shark	11	14	0.028	211	2 411	1.934
Moonfish	76	94	0.196	143	1 634	1.311
Butterfly tuna	15	19	0.039	103	1 177	0.944
Oilfish	2	2	0.005	44	503	0.403
School shark	34	42	0.088	2	23	0.018
Sunfish	7	9	0.018	65	743	0.596
Rudderfish	39	48	0.101	18	206	0.165
Flathead pomfret	56	69	0.145	0	0	0.000
Escolar	0	0	0.000	58	663	0.532
Pelagic stingray	0	0	0.000	8	91	0.073
Thresher shark	7	9	0.018	9	103	0.083
Hoki	0	0	0.000	1	11	0.009
Pacific bluefin tuna	0	0	0.000	2	23	0.018
Skipjack tuna	0	0	0.000	1	11	0.009
Striped marlin	0	0	0.000	1	11	0.009
Yellowfin tuna	0	0	0.000	0	0	0.000

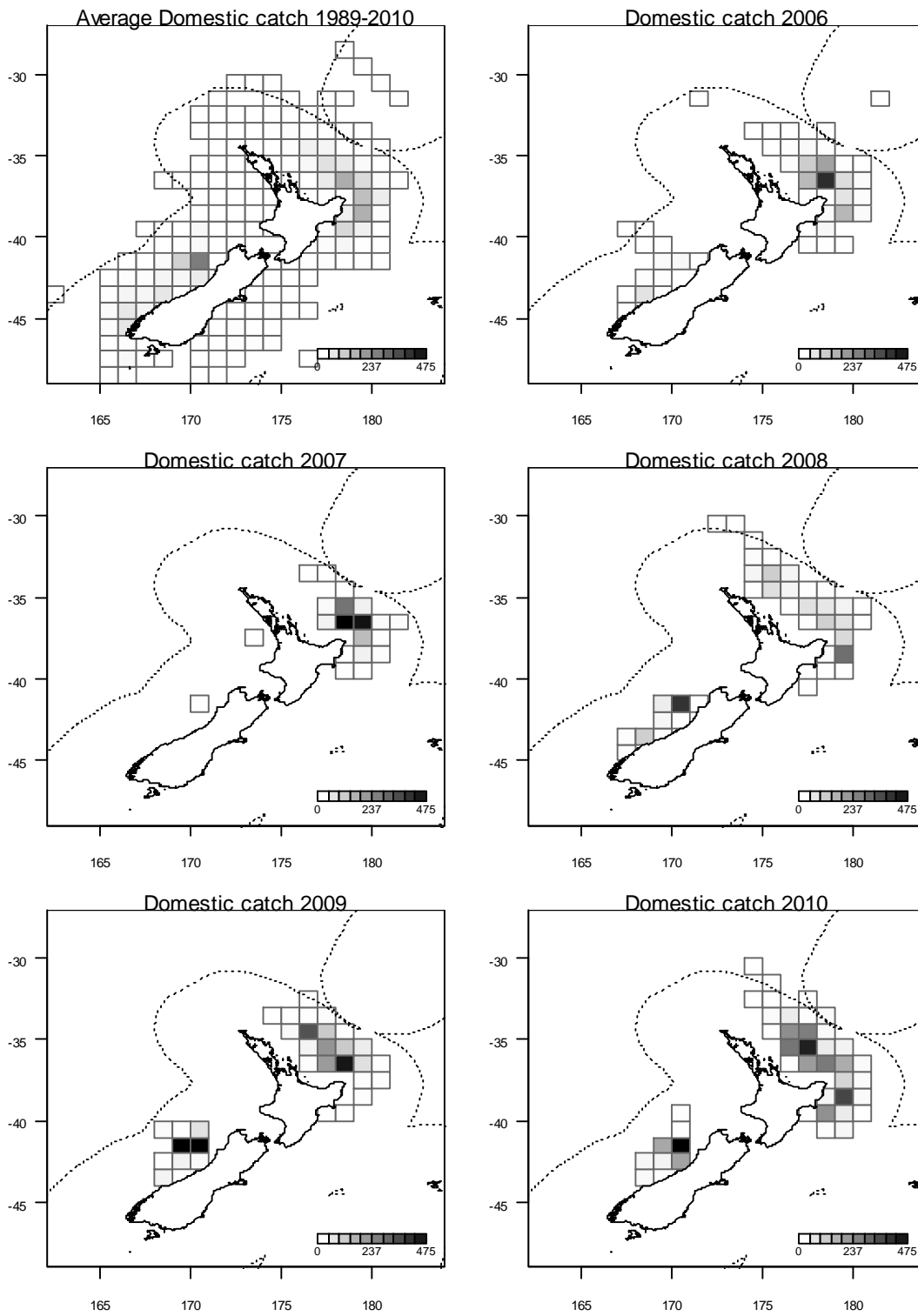

Figure 1: Distribution of longline catches (number of SBT per 1 degree square) for the domestic fleet: average for the time series (1989-2010), and annually for 2006 to 2010.

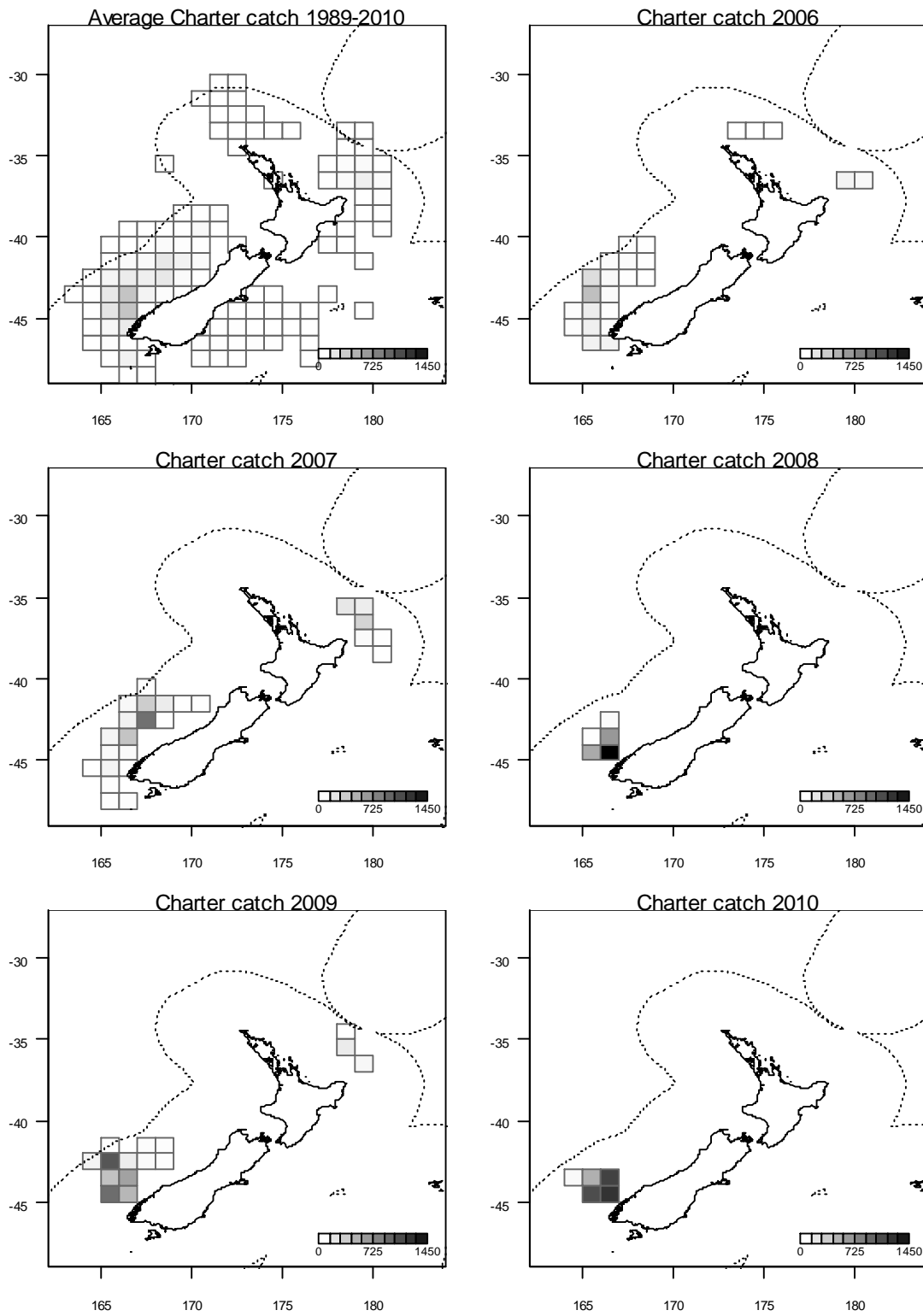

Figure 2: Distribution of longline catches (number of fish per 1 degree square) for the Charter fleet: average for the time series (1989-2010), and annually for 2006 to 2010.

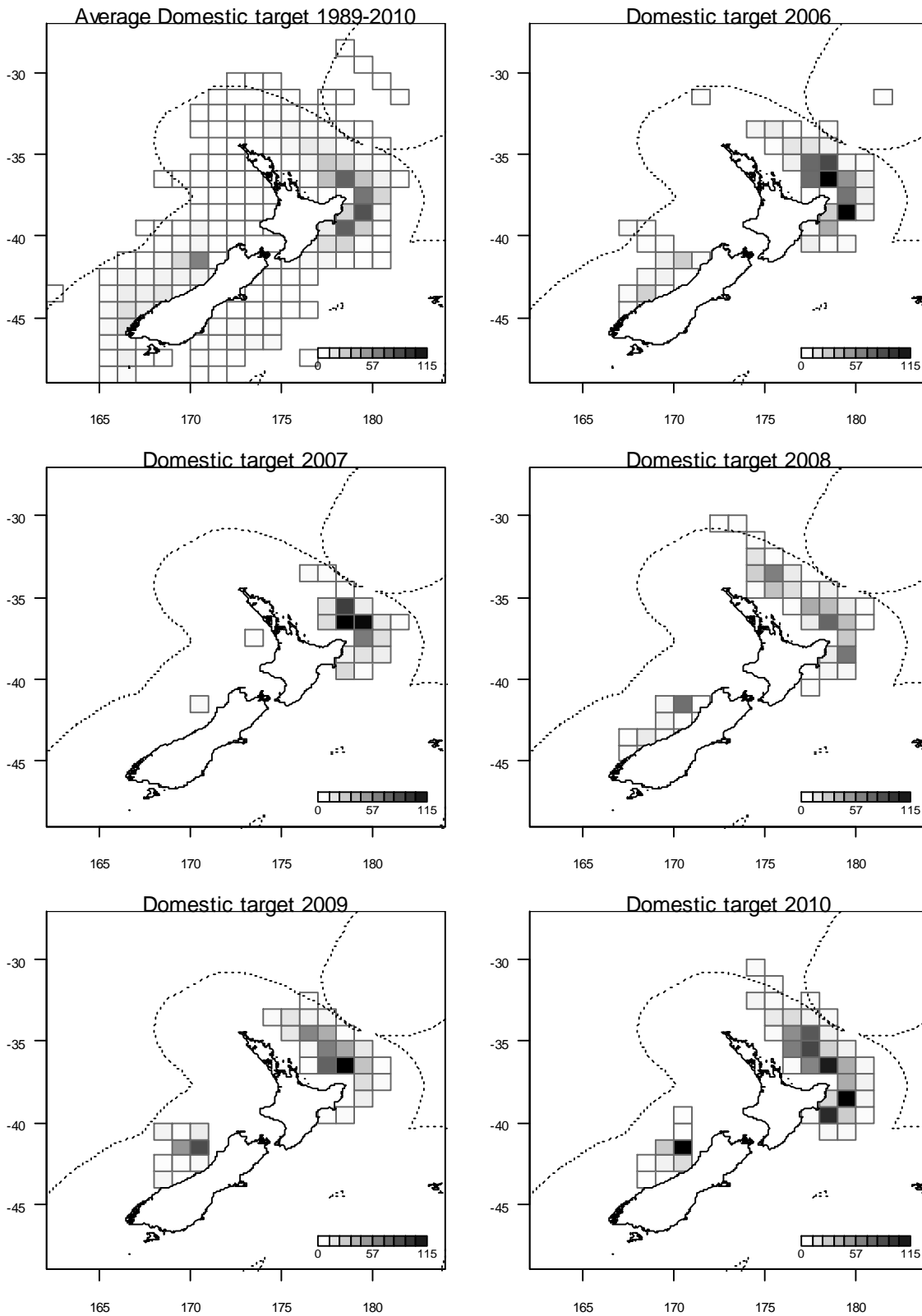

Figure 3: Distribution of longline effort (thousands of hooks per 1 degree square) for the domestic fleet that was targeted at southern bluefin tuna: average for the time series (1989-2010), and annually for 2006 to 2010.

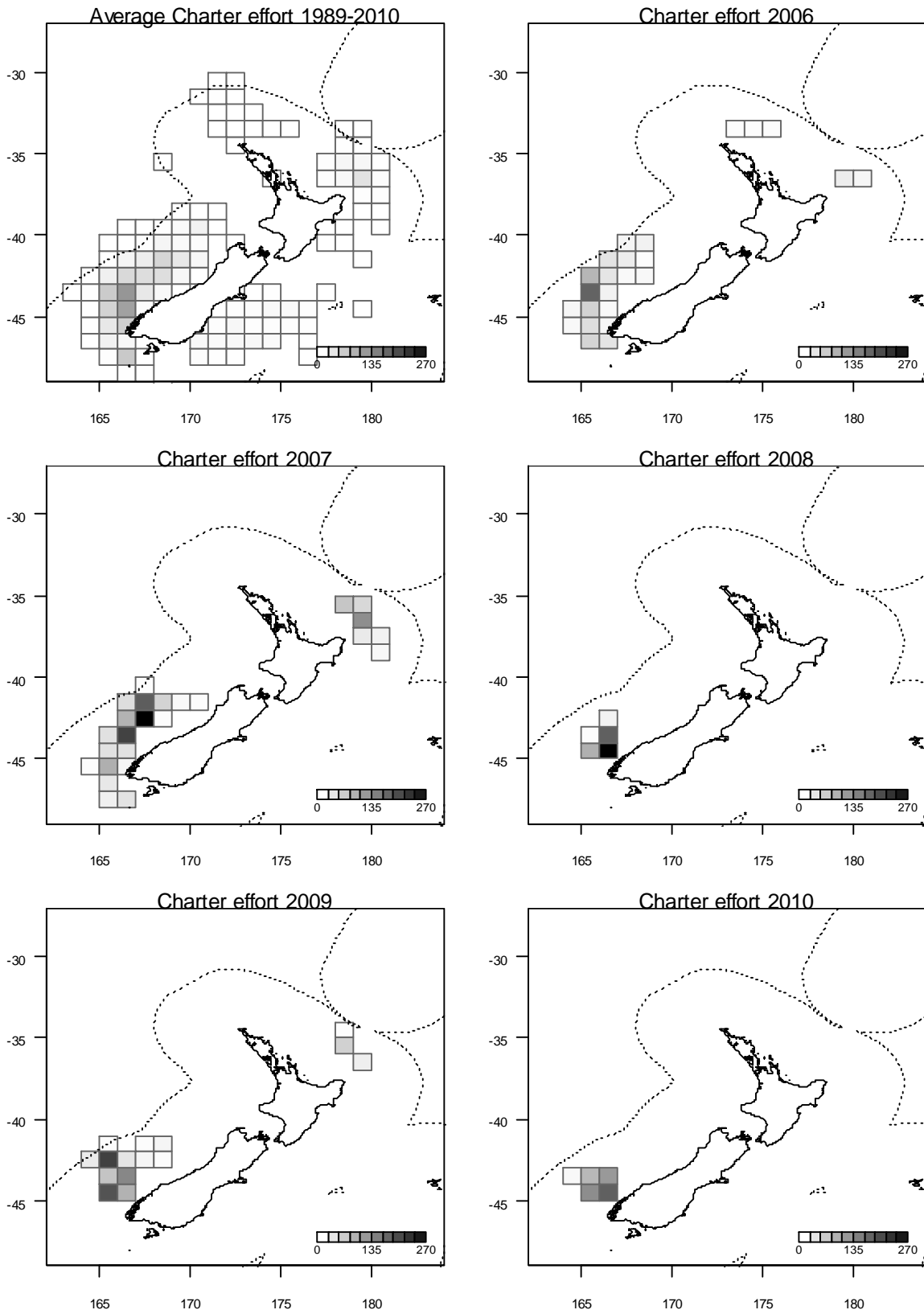

Figure 4: Distribution of longline effort (thousands of hooks per 1 degree square) for the charter fleet: average for the time series (1989-2010), and annually for 2006 to 2010.

APPENDIX I – ABSTRACTS OF NEW ZEALAND MEETING PAPERS FOR ERSWG9

Title	Ecological Risk Assessment for seabird interactions in surface longline fisheries managed under the Convention for the Conservation of Southern Bluefin Tuna
Authors	S. M. Waugh , D. P. Filippi, B. Sharp, and H. Weimerskirch
Abstract	An analysis of risk of seabird interactions with pelagic longline fisheries was undertaken using CCSBT fishing data, and a suite of albatross and petrel species known to be caught in CCSBT fisheries. The analysis followed methods developed in other regions and applied to assess risk of non-target take on highly-migratory top predator species in other RFMOs. A simple dataset describing species distribution was used as a first stage in exploring areas of greatest interaction, with hotspots of activity defined around breeding localities for each species, combined with fishing effort data on a quarterly basis. The resulting outputs showed that seasonally, the areas of greatest risk moved between the Tasman Sea, eastern New Zealand area, and the south-western Indian Ocean. The species identified as being most at risk were albatrosses. The analysis could be improved with more detailed information about species-specific catch rates in a wider range of national fisheries, and by ameliorating the species distribution information.

Title	Assessment of the risk to seabird populations from New Zealand commercial fisheries
Authors	Y. Richard, E. R. Abraham, and D. P. Filippi
Abstract	<p>Risk of incidental mortality from commercial fishing for seabird species in New Zealand fisheries is assessed by comparing the total number of birds potentially killed while fishing against the Potential Biological Removal (PBR) index (represents the amount of human-induced mortality a species can sustain without compromising its persistence). Because estimates of seabirds' demographic parameters and of fisheries related mortality are imprecise, the uncertainty around the demographic and mortality estimates was explicitly considered, which allowed uncertainty in the resulting risk to be calculated, and also allowed the identification of parameters where improved precision would reduce overly large uncertainties. The risk was estimated independently for each fishery, and there was no assumption that the vulnerability of seabirds to capture was related between different fisheries. This has the consequence that some species may be caught infrequently in well observed fisheries, but still have high risk associated with poorly observed fisheries. Many limitations were identified in the risk assessment. These may result in biased estimates (either too high or too low) of the risk of fishing to some seabirds. The conclusions should therefore be interpreted with caution, as some species might be at risk, even if their risk ratio was estimated to be lower than one. Conversely, the fisheries-related fatalities may be overestimated in poorly observed fisheries. The risk assessment method assumed a high number of captures in the absence of observations to the contrary, so the estimated potential fatalities in poorly-observed fisheries may be higher than the actual fatalities.</p> <p><i>Note that there is also a substantial supplementary information paper associated with this report.</i></p>

Title	Summary of the capture of seabirds, marine mammals, and turtles in New Zealand commercial fisheries, 1998–99 to 2008–09
Authors	E. R. Abraham, and F. N. Thompson
Abstract	<p>A summary is presented of all captures of seabirds, marine mammals, and turtles during SBT longline fishing within the outer boundary of the New Zealand Exclusive Economic Zone (EEZ) between 1998 and 2009. MAF observers record captures of seabirds, marine mammals, and turtles, along with information on fishing effort, are used for estimating total captures. The report contains time series and maps of the observed and estimated captures. Estimates of captures made using statistical modelling were available for some species groups and fisheries. These estimates were able to account for some non-representivity of observer coverage. In fisheries, areas, and years where model based estimates had not been made, and where there was sufficient observer coverage, a simpler ratio-estimation method was used to estimate total captures.</p> <p><i>Note that the SBT data presented are a subset of the total report which covers all New Zealand fisheries.</i></p>

Title	Summary Advice Statement For Reducing Impact Of Pelagic Longline Gear On Seabirds
Authors	ACAP – Report of the Sixth Meeting of the Advisory Committee
Abstract	<p>Recognising that most (84%) breeding albatrosses overlap with the pelagic longline fisheries for tuna and swordfish managed by the five tuna RFMOs, the adoption of best practice seabird conservation in these fisheries is a high priority. A combination of weighted branchlines, bird scaring lines and night setting are best practice mitigation in pelagic longline fisheries. These measures should be applied in high risk areas such as the high latitudes of southern hemisphere oceans and lower to mid-latitude fisheries of both the northern and south east Pacific to reduce the incidental mortality to the lowest possible levels. Other factors such as safety, practicality and the characteristics of the fishery should also be recognised. Currently, no single mitigation measure can reliably prevent the incidental mortality of seabirds in most pelagic longline fisheries. The most effective approach is to use the above measures in combination.</p>

Title	An Indicator-based Analysis of Key Shark Species based on Data Held by SPC-OFP
Authors	S. Clarke, S. Harley, S. Hoyle, and J. Rice
Abstract	<p>Longline and purse seine logsheet and observer datasets held by SPC-OFP were examined to assess the stock status of eight WCPFC key shark species. Both longline and purse seine logsheet datasets suffer from missing shark catch records and a lack of species-specific recording, therefore the indicator analysis was based on observer data only. Shark data from the observer data sets are, however, also constrained by a lack of representativeness, particularly for the North Pacific, and for the purse seine fishery by the physical practicalities of onboard sampling. Shark status indicators in four main classes were assessed: range based on fishery interactions, catch composition, catch rates and biological indicators of fishing pressure (e.g. median size, sex ratio). For blue sharks, which dominate longline catches in most regions, declines in catch rates were observed in nominal and standardized analyses for the northern hemisphere. In the southern hemisphere catch rates declined in the nominal analysis but increased in the standardized</p>

	<p>analysis in recent years. Both significant increases and decreases in blue shark size were identified. Data for makos in the northern hemisphere were comparatively sparse, although this species is known to be commonly found there. Catch rate analysis showed different trends in different regions and no significant size trends. The three thresher species have divergent, but not necessarily distinct distributions which, in combination with low sample sizes, produced no clear catch trends for the group. A significant decrease in median size was identified for threshers in tropical areas, most of which are expected to be bigeye threshers.</p>
--	--

Title	A Status Snapshot of Key Shark Species in the Western and Central Pacific and Potential Management Options
Authors	S. Clarke
Abstract	<p>This document synthesizes all of the shark assessment work completed to date under the Western and Central Pacific Fisheries Commission’s Shark Research Plan and discusses existing and potential conservation and management measures for sharks. The current state of eight of the WCPFC’s key shark species in the Western and Central Pacific Ocean is summarized. Various measures implemented to reduce shark mortality due to fishing are examined including the existing WCPFC shark measure and alternative measures applied by WCPFC members in national waters. Measures currently applied by other regional fisheries management organizations are evaluated and conclusions regarding status of the stocks and effectiveness of current management measures are presented.</p>

Title	Preliminary report of 2010 weighted branch-line trials in the tuna joint venture fishery in the South African EEZ
Authors	E. Melvin, T. Guy and N. Sato
Abstract	<p>Research in the South African tuna joint venture fishery in 2010 compared the performance of a revised “hybrid” streamer lines deployed with weighted (W) and un-weighted (UW) branchlines on two Japanese vessels. Seventeen birds species attended the vessel during line setting, but only four made primary attacks on baits and were killed. White-chinned petrels were the most abundant bird; they were present during all sets, attacked at the highest rate and were the bird most killed. Albatross attack rates were near two orders of magnitude lower than that of white-chinned petrels, but eight were killed suggesting strongly that secondary attacks – birds stealing baits from birds having made a primary attack – drove albatross mortality. Twenty-four of the 27 bird mortalities occurred after nautical dawn. All three birds caught at night were on UW lines. Weighting branchlines with hybrid streamer lines dramatically reduced seabird attacks, secondary attacks and seabird mortalities with little effect on fish catch. Four of 27 bird mortalities (2 white-chinned petrels, 1 shy albatross, and 1 cape gannet) were on W branchlines – a reduction in seabird bycatch rate of 86 % compared to UW. Mean tuna catch was near equal on the two branchline types, but W branchlines tangled on themselves three times more often than UW branchlines. No crew injuries occurred from either branchline type. The preliminary results indicate that the shrink and defend conceptual framework of seabird bycatch mitigation is effective. Specifically, these results strongly suggest that two hybrid streamer lines together with weighted branchlines and night setting constitute best-practice.</p>

APPENDIX II – CODE OF PRACTICE



The New Zealand Seafood Industry Council Ltd

Code of Best Practice

For Mitigating the Effects of Fishing in
New Zealand Pelagic
Longline Fisheries



2011–12 fishing year

Summary of the Code of Best Practice

The Code of Best Practice ('the Code') is designed to provide guidance to fishers, to minimise the incidental capture of protected species during their commercial fishing operations. To ensure success, longline fishers should note the following:

- Accurate records of protected species capture are recorded on the MAF 'Non-Fish and Protected Species Catch Return'.
- To accurately identify seabirds, all vessels should have on board the booklet "**A fisher's guide to New Zealand seabirds**" (DOC 2007).
- Fishers should carry and know how to operate a turtle de-hooker.
- If MAF observers are on a trip, they can help you apply the Code (e.g. providing advice on mitigation methods).
- Fishers should ensure crew members are able to effectively employ the mitigation measures.

By adopting the Code of Best Practice you accept the challenge of preventing where possible protected species captures, by implementing proactive mitigation measures to ensure that pelagic longline fishing is a sustainable activity.



The purpose of the Code of Best Practice

The Code of Best Practice sets out principles and standards of behaviour for responsible practices. It also acts as an agreed guide to existing and improved fishing practices by pelagic longline fishers within New Zealand fisheries waters. The Code is a demonstration of the long-term commitment to ensuring we maintain a well-managed, sustainable fishery. This will ensure the effective development of the fishery with due respect for the ecosystem, biodiversity, economics, community benefits and other users of the resource.

The main purpose of the Code is to document the suite of mitigation measures that help minimise the incidental capture of protected species. Mitigation measures laid out in the Code are practical, sensible and are known to work. In addition, the Code is consistent with the National Plans of Action.

The Code will evolve over time, incorporating new knowledge, research results, and technology to reduce the risk of protected species capture. A watching brief will be kept on international research in this area. The Code will be reviewed annually. The regulations summarised in this Code are subject to change.

The Code will improve over time as it evolves; feedback and new ideas are very welcome.

The contacts for any issues surrounding this code and other matters:

Contacts:

Greg Lydon (SeaFIC)

Phone: 027 244 9070

email: greg@seafood.co.nz

Michael Backhurst (MAF)

Phone: 09 820 7688

email: michael.backhurst@maf.govt.nz



Introduction

Any actions that threaten endangered marine species have become a global concern. The NZ Seafood Industry is constantly reviewing its operating standards to ensure that its fishing practices are environmentally responsible. The Fisheries Act 1996 provides for the utilisation of fisheries resources while ensuring sustainability. Fishers must take into account the effects of fishing on the environment and on associated species by avoiding, remedying or mitigating any adverse effects of fishing on the aquatic environment.

Having a clean green fishery is crucial not only for the ecosystem but in today's global market. By keeping protected species away from the lines there will be more hooks available to catch fish.

Scope of the fishery

The tuna fishery in New Zealand is complex and dynamic with many factors changing within and between fishing seasons. The fishery operates across several geographic areas and the presence, abundance and behaviour of tuna and the protected species that interact with the fishery are constantly changing in response to the environment. Similarly, vessels and fishing techniques vary widely within the fishery, as does fishing effort in response to market demand.

In general, tuna are seasonal in their distribution in New Zealand waters, and this distribution is governed largely by temperature and the distribution of food. While there are known fishing grounds for species such as Bigeye and Southern Bluefin Tuna, their time of arrival and distribution can vary from year to year.

Pelagic longline fisheries overlap with the known ranges of various seabird species, marine mammals and turtles, including some ranked as 'Critically Endangered'. The overlap of fishing operations with protected species inevitably leads to occasional fishery interactions.

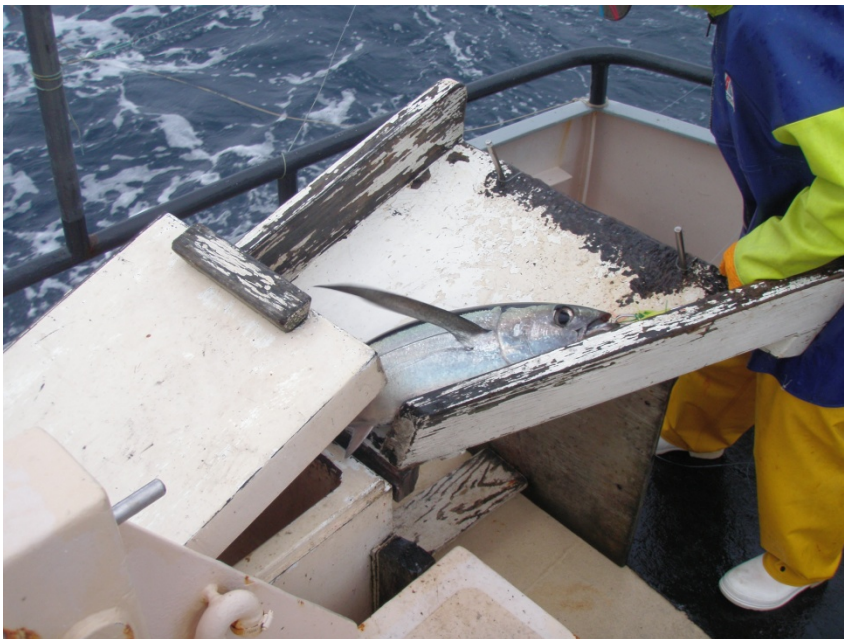

Objectives of the Code

1. Protected species captures in target tuna fisheries will be minimised and will reduce over time.
2. The effectiveness of mitigation measures will be monitored and improved over time.
3. New mitigation measures will continue to be investigated. Where new measures prove to be effective and safe they will be included in the Code.
4. Mitigation measures will not cause unsafe working conditions as the health and safety of the crew is paramount at all times.

Review

The Code will be reviewed annually by representatives from SeaFIC and MAF, in consultation with fishers.

Seabirds

The islands that make up New Zealand support the world's most diverse community of seabirds, (eighty species) and the greatest variety of albatross and petrel species in the world. 47 albatross and petrel species breed or forage in our waters, of which 20 only breed here. They are all protected. This hotspot of seabird biodiversity is called 'the seabird capital of the world'. Unfortunately, interactions between seabirds and fishing vessels sometimes occur, with some seabird species particularly vulnerable.

Seabirds are incidentally caught in a variety of fisheries and by all fishing methods each year. For some seabird species, fishing activity is a major threat, while for others the main threats are from other sources, such as loss of habitat, competition for breeding sites with fur seals and predation by introduced predators. Pollution, plastic ingestion, human disturbance on land, boat strikes and hunting are lesser threats. In addition some species have a small breeding population but a wide oceanic range which exposes them to many fisheries in different jurisdictions.

In New Zealand, 13 albatross and 17 petrel species have been recorded as having been caught during commercial fishery operations since 1996. Incidental mortality from interactions with commercial fisheries has been linked with global declines of some albatross and petrel species.



The Problem

The type and abundance of seabirds attending fishing vessels will differ depending on; the number of fishing vessels present in the same fishing grounds, the location, time of day, and season. Whether or not seabird species are at risk of being caught depends on their feeding method, how deep they dive, and the size of the seabird. Smaller birds are unable to swallow large food items such as longline baits, and so are rarely found captured in this way. However, large scavenging seabirds often have wide bill gapes and are able to swallow large food items whole increasing the likelihood of getting caught on longline hooks.

Seabirds that forage behind longline fishing vessels risk getting caught on the hook or entangled in the line if baited hooks are within the range they would normally dive to retrieve food. In some cases they are also at risk when deeper diving species are present that can bring a baited hook to the surface. Shallow diving albatrosses can take a baited hook from a smaller deeper diving petrel, which puts them at risk despite baits being set well beyond their own diving depth.

Seabirds are natural scavengers and appear to learn that fishing vessels provide a reliable easy meal during fishing operations especially when used baits and offal are discarded at sea. Seabirds can become hooked during line setting and less frequently during the haul. Seabirds can get caught by either swallowing baited hooks or by being foul hooked. They are at risk not just from the New Zealand fishery, but from other international fisheries as well.

Mitigation measures to minimise seabird captures

Unfortunately, there's no silver bullet for seabird conservation in longline fisheries – it generally involves a range of different measures, and some experimentation.

The following mitigation methods will help to reduce the likelihood of accidentally catching a seabird. Using a combination of methods improves the likelihood of preventing birds from taking baited hooks.

In general mitigation technologies work in one of five ways:

- Reduce the window of time in which seabirds can access baits, either by line weighting or delivering baits below the area where birds can access baits.
- Scare birds away when baits are deployed or retrieved.
- Disguise baits using blue dye or wrapping baits up so they are unrecognizable as food.
- Manage offal from fish processing in a way that minimises interactions during line setting and hauling.
- Time area-closures, which generally aim to minimise fishing at times and in areas when birds are breeding and most aggressive.



Observer Services

New Zealand's observer program is an important source of information for the management of pelagic longline fisheries. The information gathered is used to help us to manage our tuna fisheries, and to participate effectively in international management. Observers take on a number of roles when they are on board a fishing vessel. The main focus for observers is to gather biological and fisheries information for scientists (i.e. what is caught, including size and sex information). In pelagic longline fisheries, observers may also collect information on:

- Fish released back to the sea, including sharks and other species
- Seabirds and turtles
- Measurements to help determine appropriate conversion factors (e.g. for sharks)
- Stomach contents of target and bycatch species
- Seabird mitigation experiments
- Other requests for scientific or management information.

1. Streamer Lines

It is mandatory to always use a bird scaring line(s) when setting a longline.

Circular F629 – the Fisheries (Seabird Mitigation Measures—Surface Longlines) Notice makes it mandatory to use a streamer line (also called a tori line) when setting a longline when fishing for tuna or swordfish (See Annex 1). The circular also contains specifications that must be adhered to, and establishes the requirement to either set at night or to use line-weighting. These are the minimum standards for seabird mitigation on surface longline vessels.

Seabirds sit on, or fly low over the water behind a boat when diving and attacking baits. A bird-scaring line or lines (originally designed by the Japanese, hence ‘tori’) are suspended some distance above the deck, and are positioned over or in the area where baited hooks enter the water. They are relatively cheap to make and install and are designed to trail out behind the fishing boat to create a ‘moving fence’ that deters birds from entering the area where the fishing lines are set and hauled i.e. the ‘scarecrow’ effect prevents seabirds accessing baited hooks.

Streamer lines need to be deployed so they adequately protect your vessel’s ‘Danger Zone’ which is the area where birds can access baited hooks.

Each vessel’s streamer line will be slightly different, or specific to each vessel, to increase the effectiveness in reducing interactions with seabirds. The length of your streamer line relates to your setting speed – setting faster usually generates a larger aerial distance for the streamer line (however slower setting speed allows the line to sink at a faster rate which is also good). So an effective streamer line will take time to perfect for your vessel and is a juggling act between aerial length, setting speed and crucially the ability to keep the streamer line above your hooks while not getting entangled with your backbone. It’s not easy but once you have the streamer line working well it will keep birds away from your line most of the time.

Research worldwide has shown that streamer lines significantly reduce seabird bycatch, by up to 70% in comparison to vessels not using them. Research in Alaskan Longline Fisheries has shown that paired streamer lines (2 streamer lines either side of the backbone) are more effective and significantly reduce incidental seabird capture. This is also the case in NZ trials as paired streamer lines are robust in a wide range of wind conditions and require little adjustment as physical conditions change.

Streamer line design specifications vary by vessel, fishing operation, and location, however the streamer line needs to:

- Have a minimal risk of entanglement with fishing gear.
- Be simple to construct and repair.
- Have streamers that move freely, unpredictably and not wrap around the backbone of the streamer line.
- Set and retrieve with ease (It’s an advantage to use a small winch).

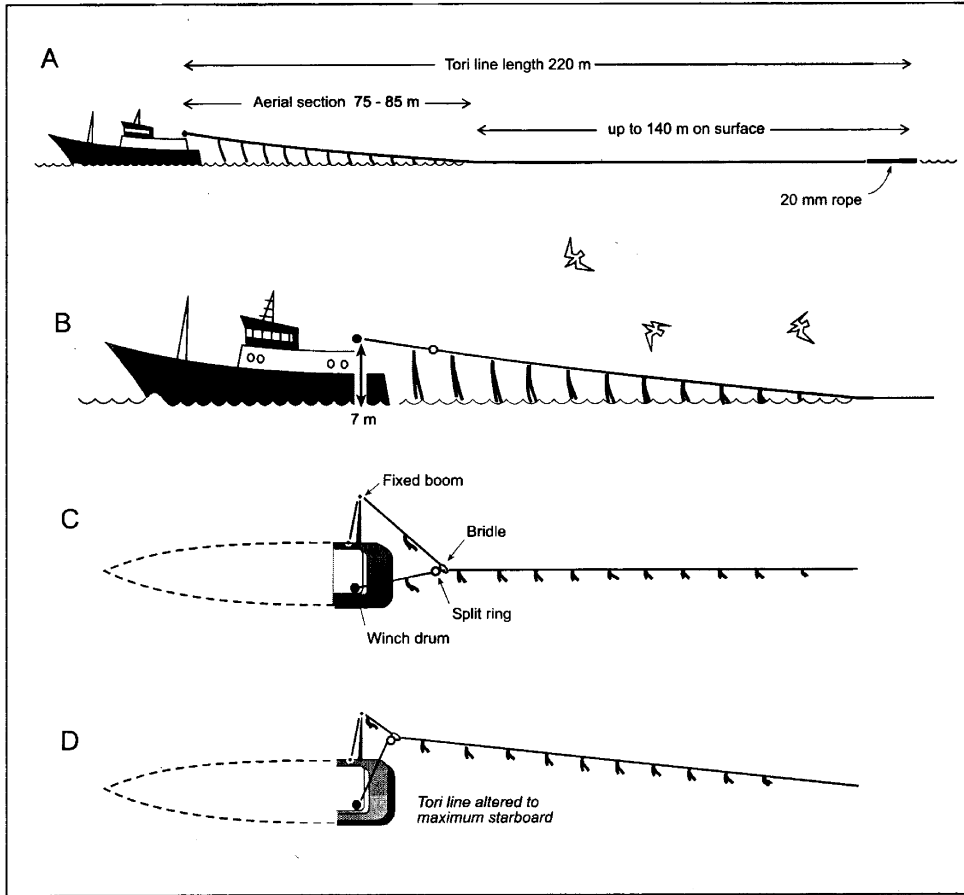

Figure: An example of a Streamer Line with Bridle and Boom system (Smith 2001)

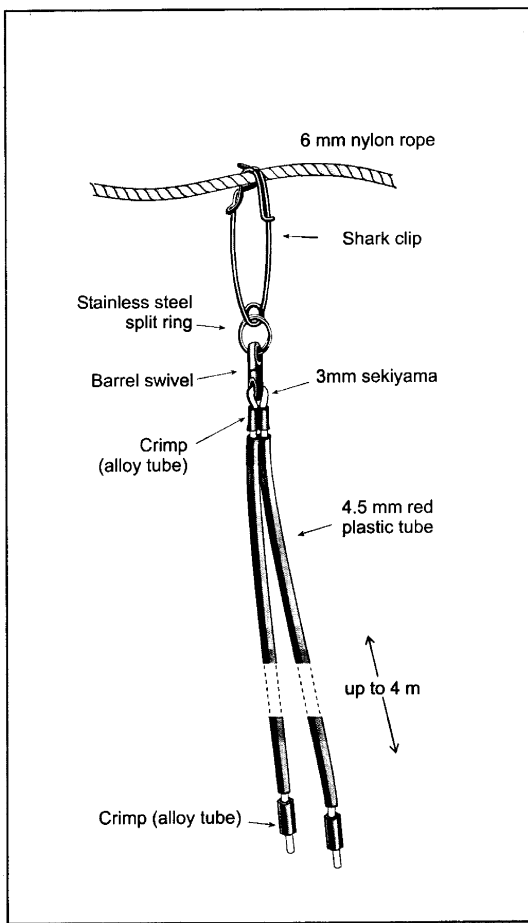

Figure: An example of Materials used in a Streamer Line (Smith 2001)

2. Disposal of Waste, Baits and Offal

Offal will not be discharged during setting and will be discharged only on the opposite side to the hauling station when hauling.

Fishing activities can provide a food supply for seabirds from discarded fish and waste. However, disposal of waste attracts seabirds to the longlining operation.

Line setting is the danger time for seabird capture – the disposal of waste overboard during this time attracts seabirds to the longlining operation and puts seabirds in danger from baited hooks.

- Only release offal when the vessel is steaming, or on the opposite side of the hauling station when hauling.
- Offal will not be discharged during setting.
- If offal or missed baits are drifting into the area where the line is being set – then steps must be taken immediately to stop this happening.

All efforts must be made to remove embedded hooks from offal.

3. Night Setting

Setting longlines at night is mandatory practice*
(*unless using an approved line weighting regime – see item 4)

N.B. Night = 0.5 hours after nautical dusk to 0.5 hours before nautical dawn

- Research indicates that more seabirds are caught on longlines set during the day.
- Setting lines at night reduces the visibility of the bait for most seabirds. However care must be taken:
 - In the hour after sunset and the hour before sunrise. This is when many seabirds are most actively feeding so are danger times.
 - In the three days before and after a full moon. Additional mitigation measures may be required at such times.
- The effectiveness of setting longlines at night depends on various factors e.g. fishing method, season, seabird species behaviour, weather, mitigation measures already in place etc.
- Vessel lighting needs to be shielded to avoid shining out onto the longline, less light on the longline helps reduce the ability of the bird to see the baited hooks.
- Crew safety is paramount so light levels must be safe on board the vessel.
- The stern deck lights should be switched off when not required for shooting and hauling as lights attract seabirds to the vessel.

4. Weighting of Hooks or Longline Gear

Weighting of longline gear increases the sinking speed of baited hooks. This reduces the exposure time of baited hooks to seabirds.

Setting in the daytime is permitted ONLY if line weighting is used i.e.

A metal weight of 45g or more must be attached to every hook deployed. The position of the weight must correspond to one of the following:

- (a) Weights less than 60 grams must be within 1 metre of the hook; or
- (b) Weights of 60-98 grams must be within 3.5 metres of the hook; or
- (c) Weights greater than 98 grams must be within 4 metres of the hook.

More info: see Gazette Notice F629, November 20011 (Annex 1)

Even if you're setting at night, line weighting can be an important mitigation tool for getting your hooks past the 'danger depth' in which they can be attacked by birds as quickly as possible. Weights can also be added to the line if other mitigation measures are not being effective.

Avoid jerking the line to the surface and exposing the hooks to birds.

Care must be taken – weights can be very dangerous especially during the hauling operation when weights can “fly” over the overboard roller.

The weighting regime depends on:

- the diameter of the backbone (thinner backbones generally sink more rapidly).
- the weather (large swells create more line jerks and slow sink rate).
- the vessel's setting speed (slower setting speeds allow the line to sink to greater depths in shorter over ground distances).

Some countries add weights to branch lines during pelagic longline fishing. Weighted swivels of between 45 – 100 grams are used 1 – 5 metres from the hook. Branch lines with weights at or near the hook cause baits to begin sinking instantly, removing the visual cue for seabirds. They also increase sinking speeds and shorten the time that seabirds are vulnerable to being caught.

Using weighted swivels at the hook end of branch lines can be dangerous under certain circumstances. When sharks are hooked, they tend to swim to the surface and if they turn while they are on the surface the branch line can run across their teeth and break. If the branch line is under tension, the swivel can become a projectile and travel at high

speed towards the vessel, creating a danger to crew. The following practices are used to mitigate risks:

- A UK company has developed a “Smart Lead” that falls off the branch line if the weight reaches dangerous speeds.
- Some Australian fishers clip their branch lines between pairs of crimps fitted at regular intervals on the mainline. This prevents the branch lines sliding along the backbone and tangling. However, in some situations this could exacerbate the risk because if the branch line comes under tension from a shark, the clip cannot slide along the backbone. This could shorten the amount of time crew has to unclip the branch line to reduce the risk of injury.
- Hauling the line through a ring at waist height is considered to reduce the risk of serious injuries to the head and upper body (compared to hauling fishing lines through a block at or above head height).
- Good coordination between the person driving the boat and those unclipping the branch lines from the mainline. For instance the forward speed of the vessel along the fishing line needs to match the pace at which crew can work, so that as soon as a branch line arrives at the ring, it is unclipped and hauled in. Under these circumstances, if a shark is caught, crew will see this sooner and can quickly clip the branch line to a low point on the vessel to reduce the chance of it hitting someone.
- In Australia, some crew wear safety helmets to protect themselves if a hook or swivel does fly back towards the boat. These are lightweight helmets with face visors that are normally used by windsurfers.

5. Thawing of bait

The use of totally frozen bait is to be avoided

Generally, frozen bait sinks at a slower rate.

Bait must be taken out of the freezer or ice several hours before the set.

6. Blue Dyed Bait



Fishers in the United States during the mid-1970s were the first to experiment with dyed baits to improve swordfish catches in the Atlantic Ocean longline fishery. The dyes that have been used internationally are commercially available non-toxic food colouring dyes. Fishers consider that dyed bait is more visible to target fish (so leads to better catch rates of tuna). Dying bait with an environmentally-safe blue dye has been shown to reduce seabird interactions in experiments in Hawaii, Australia and Japan. Birds either find it harder to see blue baits or distrust its unusual appearance. The catch rate of fish when using blue bait is not reduced.

Method

Squid bait turns a darker blue than sanmar or pilchard (this is because sanmar and pilchards have oily skin and large scales). It is recommended that blue is the only colour of dye used and squid bait is used to obtain best results.

Bait is dyed blue at sea using 30 grams (five heaped standard teaspoons) of *Brilliant Blue* dye placed in a one litre container in the sheltered wheelhouse and then thoroughly mixed with 800 millilitres of freshwater. The concentrated dye mixture is poured into a 200 litre plastic drum on deck which contains 40 litres of seawater and 400 squid (the process is repeated for a second drum containing another 400 baits). To ensure that all the bait surfaces had maximum exposure to the dye and that the bait had thawed the bait and dye mixture is regularly stirred with a broom over the course of one hour before the longline set commences. The result is a consistent

dye uptake by the squid bait (i.e. an even blue colour).



Blue dyed squid compared to normal squid bait.

7. Haul Mitigation

Up to a quarter of seabirds are caught on the haul, rather than during setting. Seabirds caught during the haul are usually alive. On larger vessels “bird baffle” or “brickle curtain” devices can be used to scare away birds. These may be difficult to use on smaller fishing boats, in which case improvised devices to scare away birds, such as short streamer lines or jets of low powered water may be used instead.

You can also refer to a factsheet produced by Birdlife International and ACAP: **“Bycatch mitigation Fact Sheet 12 - Demersal and Pelagic Longline Haul mitigation.”**

8. Careful Handling of Live Seabirds

If seabirds are caught alive, every reasonable effort should be made to ensure that birds are released alive and unharmed.

The Department of Conservation can supply this free DVD:

“Seabird Handling after Captures in Fisheries – how to help yourself and the birds”

- When you see a bird caught on your line, stop drag on the gear (take vessel out of gear/reverse to bring bird alongside).
- You will need gloves, long sleeves, a dip net, and another crewman to help you.
- When you can reach the bird, bring it gently onboard by hand or with the long-handled dip net.
- Once the bird is onboard, keep it calm, move slowly around the bird - covering the bird’s eyes and head with a cloth can help calm it.

- Hold the wings gently but firmly to the bird's body, support the head/neck and feet, gently but securely.
- Your crewmate then needs to gently isolate the hooked or tangled area.
- Carefully cut all line off the bird.
- To remove hooks – if hooking is through a body part, trim the line and cut barbs off the hook. Use bolt-cutters or cut the hook in two and thread the hook out.
- If the hook has been swallowed do not pull on the visible line. Cut the line as close as possible to the swallowed hook and leave the hook in place.
- After removing the bird from fishing gear, if the bird is waterlogged, put it in a safe space, e.g. an empty fish crate, box, or an open, safe area on deck.
- Let the bird dry out. When the bird is dry or active again ease the bird back into the water as close to the water surface as possible.
- Do not throw seabirds into the air!

Reporting information

- Accurate records of seabird capture (dead or alive) are to be recorded on the 'Non-Fish and Protected Species Catch Return'.



Turtles

Although sea turtles are typically thought of as tropical animals living around Hawaii and northern Australia, there are five species that visit New Zealand waters from time to time. These are Leatherback, Loggerhead, Hawksbill, Green and Olive Ridley turtles. Globally, sea turtles are in trouble. All species found in New Zealand waters are threatened with extinction, and two of these are critically endangered. Only one in a thousand turtles is thought to survive from hatching to breeding age.

Turtles are amazing creatures and have been on this planet for over 200 million years. Unfortunately they are critically endangered and face threats from hunting, egg collection, boat strike, pollution, climate change and accidental capture by fishing. Fortunately they are usually caught alive when they get entangled in pelagic longlines and can be safely released by the careful use of line cutters.

MARINE REPTILES

TURTLES:

TLE

- **Green turtles (GNT)** are up to 1.5 m in length, and weigh up to 200 kg. They have a hard shell of bony scutes (plates), olive green to brown in colour.
- **Loggerhead turtles (LHT)** are around 1 m in length and reddish-brown to orange-brown in colour. They can be up to 100 kg in weight.

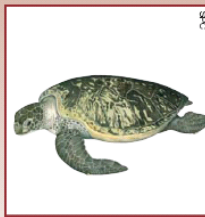

Green Turtle

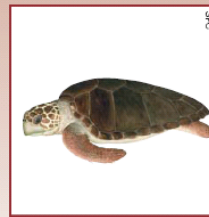

Loggerhead Turtle

TURTLES

MARINE REPTILES

TURTLES:

TLE

- **Leatherback turtles (LBT)** are up to 2.7 m in length and weigh up to 900 kg. They have 3 prominent ridges running the length of the shell instead of plates. They are dark green to grey in colour with small patches of lighter colour over the body.



Leatherback Turtle

TURTLES

The following two DVDs have been supplied to you with the de-hooking kit, they are excellent guides on how to release turtles alive. Please make sure your crew has also watched them.

'Crossing the Line' – Sea Turtle Handling Guidelines

'Hooks Out and Cut the Line' – de-hookers and linecutters

Large circle hooks (18/0) and setting deeper (below 40m) help to avoid interactions with turtles.

N.B. turtles may appear lifeless but are not necessarily dead – they may just need time on board to recover.

In summary, if a turtle is caught by being hooked or more commonly entangled in your longline:

1. If a turtle is noticed on the line, slow down to reduce trauma to the animal.
2. If the turtle is too large to bring on board, bring it as close to the boat as possible without putting strain on the line – then cut the line as close to the turtle as possible. Don't jump in the water to untangle the line.
3. If the turtle is small – use the supplied dip net to lift on board the boat. Make sure you don't use a gaff or pull on the line, or grasp the eye sockets of the turtle.
4. Place a piece of round wood (a broom handle) in the turtles mouth so that it cannot bite you – bites can be nasty.
5. If the hooks barb is visible use bolt cutters to cut off the point. Then remove the two parts of the hook separately.
6. If the hook is not visible remove as much line as possible without pulling too hard. Then cut the line close to the turtle.
7. If the turtle is active then you can carefully release it after noting tag numbers (if it has tags).
8. If the turtle is not active then it may have water in its lungs. Raise the rear flippers by 20cm while it is recovering.
9. Place the turtle in a shaded location on the boat. Cover the turtle's body with wet towels, avoiding the nostrils. Spray the towels with salt water, again avoiding the face.
10. Keep the turtle on board for at least 4 hours. Assess its recovery – it can be released when it is lively again – this can take up to 24 hours.
11. Carefully return the turtle to the water when it has recovered. Release it headfirst while the boat is stopped and the engine is out of gear.
12. Ensure the turtle is well clear of the boat before starting your engine.

Do not land animals on board if there is the possibility this will cause further injury and stress. Hauling animals to the deck using the line may result in increased tissue damage by the hook, possibly piercing the oesophagus or stomach or pulling organs from connective tissue and killing the animal. Cut the line off as close as possible to the animal.

Where practical use the DOC supplied line cutters to cut as much line as possible off an entangled animal. Where practical use de-hooking devices to remove hooks from internally (e.g. throat hooked) or externally hooked animals.



Line cutter

Where practical use dip-nets (long enough to reach the animal from the fish door) to retrieve small animals that require further treatment. For animals that can be brought aboard, land them gently to avoid damage.

If you're using the de-hooking or line cutting gear for fish, remember rough handling will increase the amount of damage and create a greater risk of fungal and bacterial infection that can cause death after release. As a fish's skin is particularly prone to injury, handling that causes a loss of scales and damage to the skin's mucus producing cells should be avoided. Use wet gloves when handling fish.

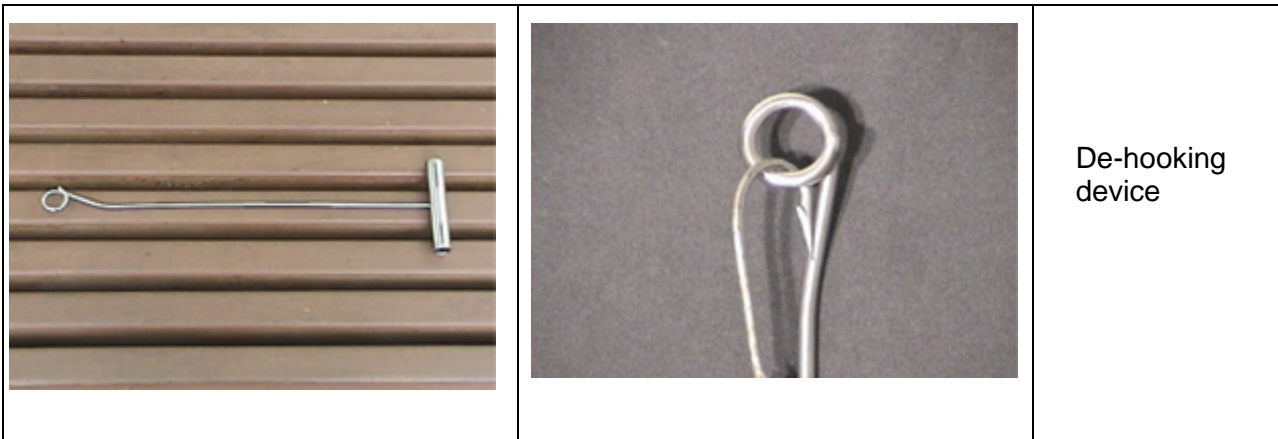

Sharks



Photo credit: D.Engel & A.Maeker

Some of the world's shark stocks are at risk from over-fishing. We now know that as a top predator, sharks play an important role in maintaining healthy ocean ecosystems. New Zealand is home to over 100 species of shark, and New Zealand has a global responsibility to manage and conserve our shark species. The Ministry of Agriculture and Forestry has produced a National Plan of Action for Sharks (2008; with a review planned for 2012) to address this responsibility. The overarching goal of the NPOA-Sharks is *'to ensure the conservation and management of sharks and their long-term sustainable use'*. The great white shark, basking shark, deepwater nurse shark, whale shark, and manta and devil rays are protected, meaning none of these species can be retained or landed.

If you intend to retain a shark, it must be killed humanely before being processed. To ensure that the shark is dead, cut through the backbone behind the head and then behind the dorsal fin.

Live finning of sharks constitutes ill-treatment and is an offence under the Animal Welfare Act.

Porbeagle, blue, and mako sharks can be released alive under the 6th Schedule. Returning live sharks to the sea – particularly juveniles and large females – helps protect the species from becoming overfished, which is of global concern. All sharks released under 6th Schedule provisions need to be recorded on landing returns (not just catch effort returns). There is a special code ('destination X') so that released catch doesn't count against ACE.

The 6th Schedule also applies to rough and smooth skates and spiny dogfish. Conditions require all these species to be released as soon as practicable after capture; the fish must be alive at the time of release and considered likely to survive on return to the sea. Spiny dogfish is the exception – they may be returned to the sea alive or dead (but all releases must be recorded, and count against ACE). When releasing sharks, make sure that the hook is carefully removed. If you cannot safely remove the hook – cut the nylon as close to the shark as possible.

Marine Mammals

Marine mammals include whales, dolphins and seals.



New Zealand fur seals (*Arctocephalus forsteri*) are protected under the Marine Mammals Protection Act 1978, and are listed by DOC (2009) as 'not threatened' and are currently increasing in numbers and expanding their breeding distribution northwards around the New Zealand coast.

Fur seals are occasionally caught alive. Gently pull the animal alongside the boat and use line cutters to cut off all of the line as close to the animal as possible. All material needs to be cut away or untangled because any line left can result in a slow death for the animal. Dispose of old line on shore. Be very careful as a bite from a fur seal is nasty. Never jump in the water to untangle line.

Dolphins, Small Toothed Whales and Pilot Whales

Dolphins and small whales are very occasionally caught alive (it is a rare event). Gently pull the animal alongside the boat and use line cutters to cut off all of the line as close to the animal as possible. All material needs to be cut away or untangled because any line left can result in a slow death for the animal. This must be done quickly or the animal will drown. It is best to support the head above the water at the side of the boat using a thick piece of rope placed under the body. Never hang the dolphin or whale up by its tail as it may suffer spinal injury. Never jump in the water to untangle line.

Loss of Gear

All reasonable precautions should be taken to prevent the loss of longline fishing gear.

Annex 1: Fisheries (Seabird Mitigation Measures—Surface Longlines) Circular 2011 (No. F629)

Extract from *New Zealand Gazette*:

Fisheries (Seabird Mitigation Measures-Surface Longlines) Circular 2011 (No. F629)

Pursuant to Regulation 58 and 58A of the Fisheries (Commercial Fishing) Regulations 2001, the Fisheries Manager Highly Migratory and Pelagic, Ministry of Agriculture and Forestry (acting pursuant to a delegated authority in accordance with section 41 of the State Sector Act 1988) gives the following notice.

Circular

1. Title

This circular is the Fisheries (Seabird Mitigation Measures-Surface Longlines) Circular 2011.

2. Commencement

This circular comes into force the day after its notification in the *New Zealand Gazette*.

3. Interpretation

In this circular:

"Act" means the Fisheries Act 1996;

"nautical dawn" means the time at sunrise when the centre of the sun is at a depression angle of 12 degrees below the ideal horizon for the place;

"nautical dusk" means the time at sunset when the centre of the sun is at a depression angle of 12 degrees below the ideal horizon for the place;

"set", in relation to a surface longline, means releasing the surface longline into the water;

"surface longline" means a line to which a hook or hooks (whether baited or not) are attached, and that is:

- (a) suspended by floats; and
- (b) not attached to the sea floor;

"streamer line" means the type of bird scaring device, also known as a tori line, as described in clause 6 of this circular.

4. Restrictions on use of surface longlines

No commercial fisher may set surface longlines to take fish, aquatic life or seaweed within New Zealand fisheries waters between the hours of 0.5 hours before nautical dawn and 0.5 hours after nautical dusk, unless line weighting is employed in accordance with clause 5 of this circular.

5. Line weighting

(1) For the purposes of clause 4, a metal weight of 45 g or more must be attached for every hook deployed.

(2) The position of the weight must correspond to one of the following:

- (a) Weights less than 60 g must be within 1 m of the hook; or
- (b) weights of 60g-98 g must be within 3.5 m of the hook; or
- (c) weights greater than 98 g must be within 4 m of the hook.

6. Streamer line required if surface longlines used

If a commercial fisher uses a surface longline to take fish, aquatic life or seaweed within New Zealand fisheries waters, the commercial fisher must:

- (a) carry a streamer line on board the vessel used by the commercial fisher; and
- (b) use the streamer line in accordance with clause 7; and
- (c) permit inspection of the seabird scaring device on board the vessel used by the commercial fisher at any reasonable time by a fisheries officer or an observer appointed under section 223(2) of the Act.

7. Streamer line specifications

- (1) The streamer line must meet the following specifications:
 - (a) The streamer line must be attached to the vessel so that when deployed the baits are protected by the streamer line, even in cross winds;
 - (b) The streamer line must be a minimum of 100 m in length;
 - (c) If a streamer line is less than 150 m in length, a towed object must be attached to the end of the tori line so that the aerial extent of the line is maintained over the sinking baited hooks.
 - (d) The streamer line must achieve a minimum aerial extent of 50 m;
 - (e) Streamers must be brightly coloured, and must be spaced at a maximum of 5 m, commencing not more than 5 m from the stern of the vessel and extending thereafter along the aerial extent of the line. When a streamer line is deployed, each of the streamers must reach the sea surface in the absence of wind and swell. Streamer length will therefore vary depending on the height of their attachment point above the water;
 - (f) The streamer line must be suspended from a point on the vessel at least 5 m above the water in the absence of swell;
 - (g) If the streamer line that is in use breaks or is damaged, it must be repaired or replaced so that it meets these specifications before any further hooks enter the water.
- (2) The specifications do not apply to additional or secondary seabird scaring devices fishers may choose to use (such as a second tori or streamer line).

8 The Schedule

- (1) The Schedule provides further guidelines on the design and deployment of streamer lines as seabird scaring devices.
- (2) The Schedule is not part of the specifications.
- (3) If there is any inconsistency between the guidelines in the Schedule and the specifications, the specifications prevail.

Schedule

Seabird Scaring Device (Streamer line)

*Diagram not to scale
Not all specifications illustrated*

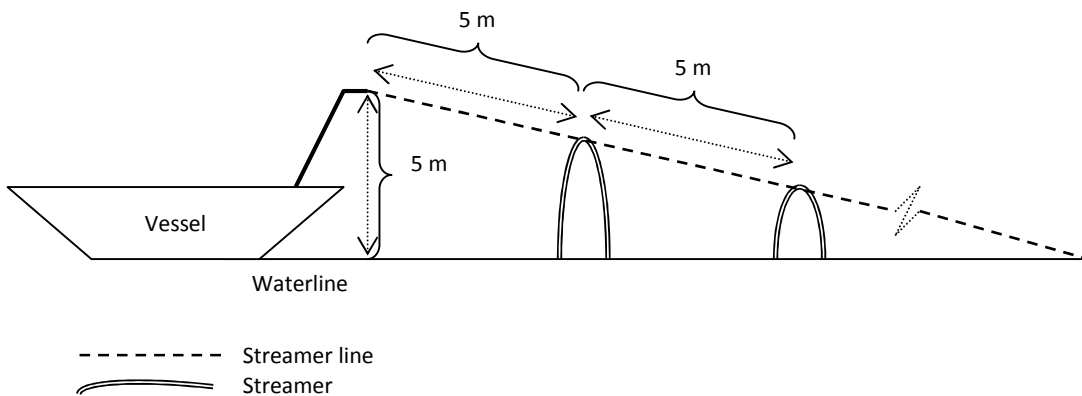

(4) The streamer line needs to protect baited hooks from seabirds. This means that the streamer line should be positioned in such a way that streamers are flapping in an unpredictable fashion, above the area in which the baited hooks enter the sea, so that seabirds are deterred from attempting to take bait from the hooks. In order to achieve this even during cross-winds, it is expected fishers will have to make adjustments to the configuration of the streamer line depending on the conditions.

(5) It is generally recognised as best practice to maximise the aerial extent of the streamer line, because this maximises the area in which the baited hooks are protected from seabirds. Best practice would be to achieve an aerial extent of 100 m. In order to maximise aerial extent, it is necessary to create tension in the streamer line. This can be achieved by:

- (a) towing an object on the terminal end of the streamer line; or
- (b) towing extra length of streamer line; or
- (c) increasing the diameter of the in-water section of the streamer line.

(6) The towed object could be a cone or buoy, a section of heavy rope, or any other object that creates sufficient drag to maintain the streamer line's aerial extent.

(7) In order to be effective at scaring seabirds away from the line of baited hooks, the streamer lines should not become tangled, either with each other or with the branch-line. Each streamer shall be attached to the streamer line in a manner to prevent fouling of individual streamers with the streamer line, and to ensure individual streamers reach the waterline in the absence of wind or swell. Swivels or a similar device can be placed in the streamer line in such a way as to prevent streamers being twisted around the streamer line. Each streamer may also have a swivel or other device at its attachment point to the streamer line to prevent fouling of individual streamers.

(8) Streamers are to be spaced at 5 m intervals along the aerial extent of the line. The total number of streamers in use will vary depending on how the line is configured. Streamers that are hanging in the water can be prone to tangling. Because the far end of the streamer line will frequently be in the water, fishers may not wish to have streamers the whole way down the line. However, it is important that streamers are present to deter birds from taking baited hooks all along the part of the line that remains above water, as outlined in the specifications.

(9) To ensure streamers are visible to birds, they should stand out against the surroundings. Streamers should be made of brightly coloured fluorescent plastic tubing or other material. Bright colours such as red, yellow, orange or pink are most effective during day setting. For night setting, the streamers should be of a colour that contrasts with the surroundings. Colours such as blue and green are less likely to be effective, because they are less likely to be highly visible to birds.

(10) In order to comply with the regulations, a streamer line must be used when setting surface longlines. If the streamer line that is in use breaks or is damaged, it must be repaired or replaced so that it meets these specifications before any further hooks enter the water. For this reason, a complete additional streamer line should be carried as a spare.

9. Revocation—The following notice is revoked:

Fisheries (Seabird Scaring Devices Minimum Standard and Procedures) Notice 2007 (No. F414)